

Referencias, nombres y táxones: identificadores, datos enlazados, web semántica

Francisco Pando



Guión



- Web semántica
- Datos enlazados
(Los dioses antiguos y nuevos)
- Una propuesta para organizar, publicar, integrar y mantener información especies
(Un plan para conquistar el mundo)

Los dioses antiguos

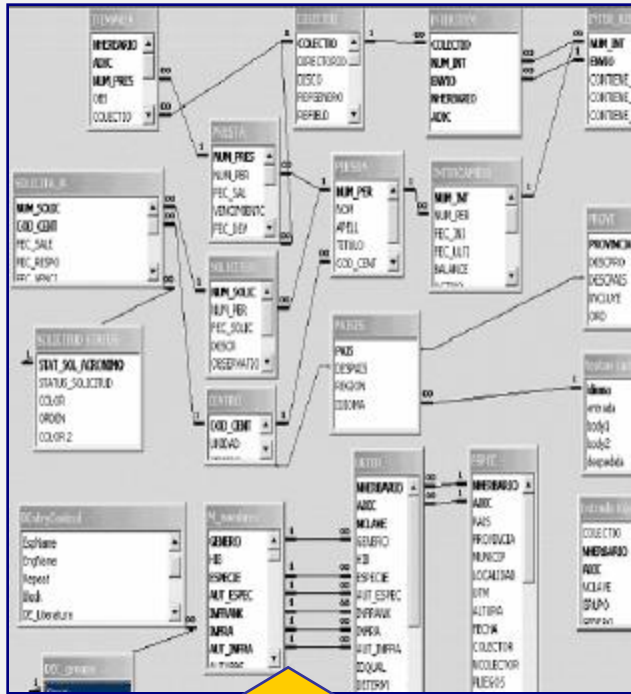

Attr#	Name
1	ScientificName
2	Kingdom
3	Phylum
4	Class
5	Order
6	Family
7	Genus
8	Species
9	Subspecies
10	InstitutionCode
11	CollectionCode
12	CatalogNumber
13	Collector
14	Year
15	Month
16	Day
17	Country
18	StateProvince
19	County
20	Locality
21	Longitude

CatalogNumber	Unique identifier for the specimen record within
Collector	The name of the collector or collectors that were (observation) from the field.
Year	The year (four digit) in which the specimen was
Month	The month of the year (1..12) in which the speci
Day	The day of month that the specimen was collec
Country	The country or major political unit (ocean) from
StateProvince	The state, province or region (i.e. next political r
County	The county (or shire, or next political region sma
Locality	The locality description (place name plus option
	specimen was collected.



La compatibilización entre sistemas se hace "a mano"

Los dioses nuevos: Web semántica: comunicar contenidos, no documentos

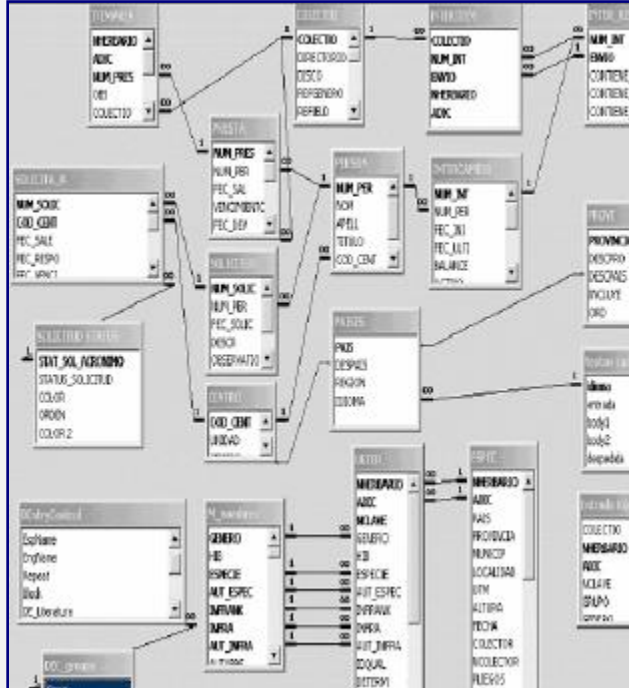

Las definiciones de las bases de datos se almacenan (o hacen uso) en un sistema:

- *Accesible vía Web*
- *Ininteligible por “maquinas”*
- *Relaciona conceptos, relaciones e instancias*

→ ontologías

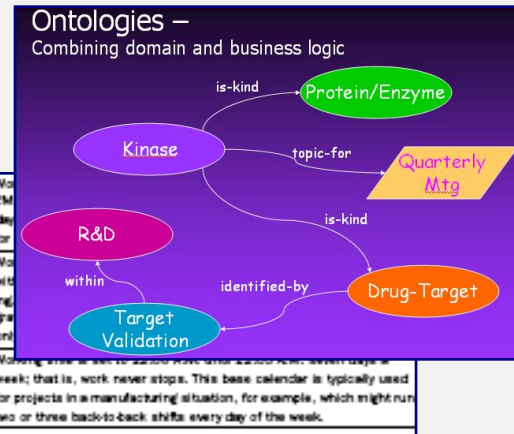
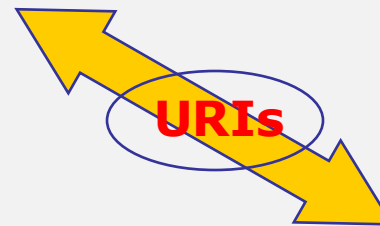

Standard	Work 8M day for
Night Shift	Work with ing, etc and
24 Hours	Working time is 24 hours per day, 24 hours per week, that is, work never stops. This base calendar is typically used for projects in a manufacturing situation, for example, which might run two or three back-to-back shifts every day of the week.

Web semántica: Triple storage, RDF*

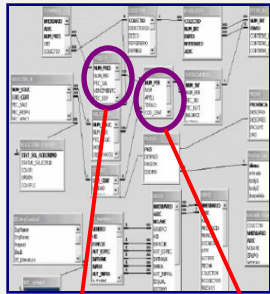

<i>Sujeto</i>	<i>Predicado</i>	<i>objeto</i>
25322	genero	Inga
25322	especie	alba
25322	pais	COL
COL	Pais largo	Colombia

XML

Especimenes	
<i>Campo</i>	<i>valor</i>
<i>Nmr_ejemplar</i>	25322
<i>genero</i>	<i>Inga</i>
<i>especie</i>	<i>alba</i>
<i>pais</i>	<i>COL</i>

Pais	
<i>Campo</i>	<i>valor</i>
<i>Pais</i>	COL
<i>Pais largo</i>	<i>Colombia</i>



Ontologies –
Combining domain and business logic

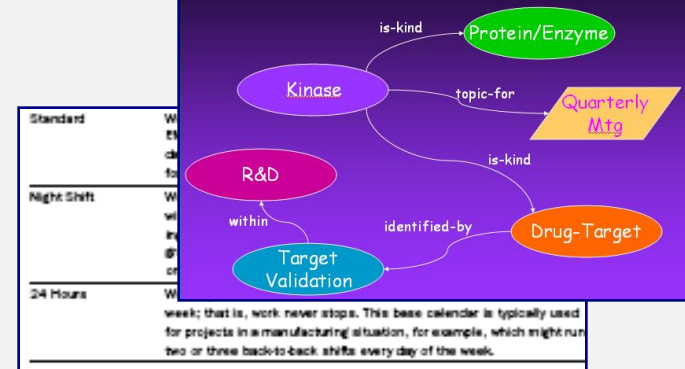

*Resource Description Framework

Web semántica: identificadores únicos

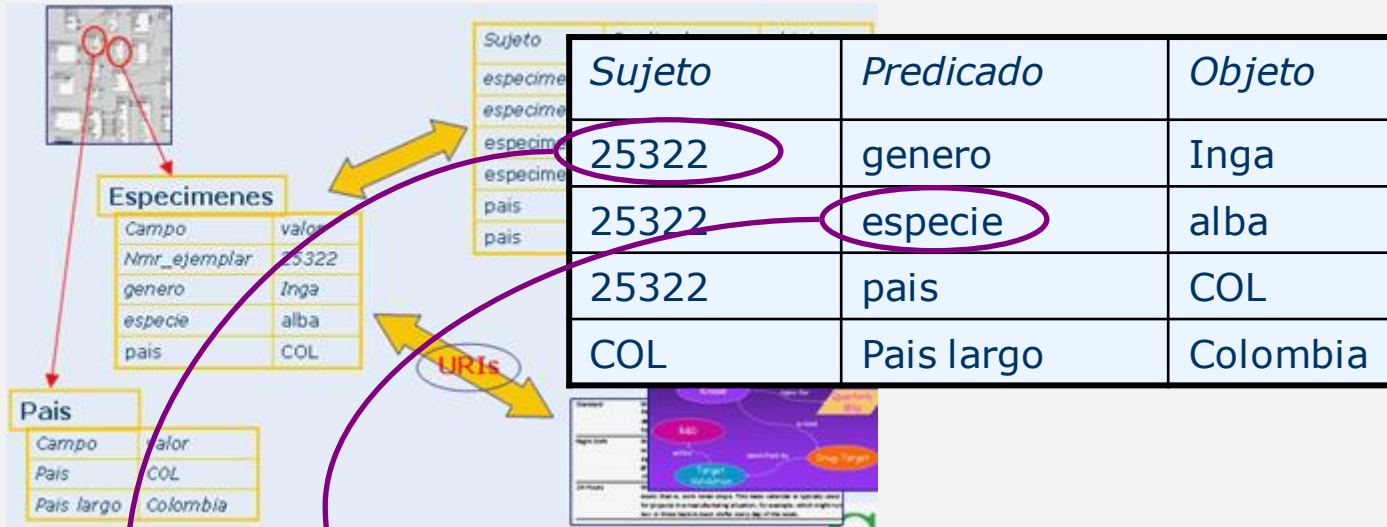

• *Identificadores únicos de conceptos (ontología)*

• *Identificadores únicos de objetos*

Web semántica: Identificadores únicos de objetos > LSIDs

Life Science Identifiers (LSID) son un tipo de identificadores globales

- Únicos
- Universales
- Se pueden resolver (esto es, los entienden las máquinas)
- Se pretende que sean persistentes
- Facilitar comunicación e intercambio
- Más robustos que URL
- Con metadatos
- Arquitectura que permite descubrir datos de fuentes independientes

urn:lsid:esa.org:esa:26:3

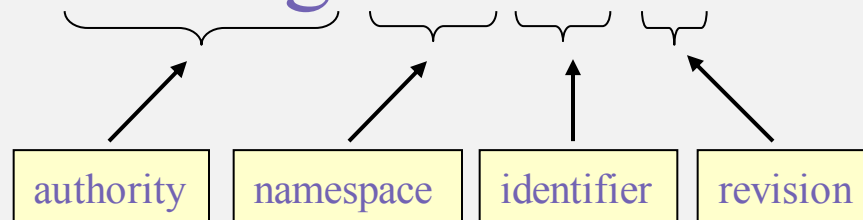

Accepted by N. Evenhuis: 14 Apr. 2009; published: 14 Jul. 2009

urn:lsid:zoobank.org:pub:E585D33C-262E-4796-A834-5FEAD656FE1F

Otros identificadores

- DOIs
 - p.ej.: <http://doi.org/10.15470/gprffz>
 - Centralizado
 - Metadatos no estandarizados

- UUIDs – 128 bit string, guaranteed unique
 - p.ej.: 58f202ac-22cf-11d1-b12d-002035b29092
 - Sin metadatos
 - Sin resolución

Web semántica: Identificadores únicos de conceptos > URIs; Vocabularios controlados

Term Name: Occurrence	
Identifier:	http://rs.tdwg.org/dwc/terms/Occurrence
Class:	
Definition:	The category of information pertaining to evidence of occurrence
Comment:	For discussion see http://code.google.com/p/dwc/
Details:	Occurrence
Term Name: Event	
Identifier:	http://rs.tdwg.org/dwc/terms/Event
Class:	
Definition:	The category of information pertaining to an event
Comment:	For discussion see http://code.google.com/p/dwc/
Details:	Event
Term Name: dcterms:Location	
Identifier:	http://purl.org/dc/terms/Location
Class:	
Definition:	A spatial region or named place. For Darwin Core
Comment:	For discussion see http://code.google.com/p/dwc/
Details:	http://dublincore.org/documents/dcmi-terms/



free and open access to biodiversity data
GBIF VOCABULARIES

Vocabularies Extensions Log In Help

This site provides mapping tools for a range of community-supported Vocabularies and Darwin Core Extensions. Vocabularies act as standardized multilingual thesauri which can be accessed and edited through a user interface as well as through XML (RESTful) web services and text (TSV & CSV) files from this site. Based on internationally recognized standards (e.g. ISO and TDWG) these vocabularies form a core component of all biodiversity data and are intended to facilitate the integration and harmonization of distributed datasets such as museum and GBIF collection records, data for the EOL and databases like the EDIT Scratchpads.

Welcome

Vocabularies

List of vocabularies served and editable through this site. If you would like to be able to create a Vocabulary, request permission.

Vocabulary	Status
basisOfRecord	review
Biological status of accession	draft
Collecting/acquisition source	draft
Country	review
DCMI Type Vocabulary	review
Drupal Development Vocabulary	draft
General GBIF Glossary	draft

Extensions

This list of extensions is in development. For more information on Extensions are uniquely identified within this site using the concatenation of the

Title	Status	Last Updated
Audubon Core v1.0.1	draft	2011-12-22 14:03
EOL Data Object ver. 1	draft	2009-12-04 17:05
Event Attribute	draft	2009-12-04 17:05
Germplasm (0.1)	draft	2011-12-28 10:04
Germplasm Accession	draft	2011-12-28 11:27
GISIN Species Status	deprecated	2011-10-31 21:00
GNA Alternative Identifiers	draft	2010-05-31 16:53
GNA Literature References	draft	2010-05-31 16:53

Ontologías

An ontology is a way to represent knowledge, by describing the types or classes of entities within a given domain and the relationships among them. By providing standardized definitions for the terms used by scientists to represent these classes, and by defining the logical relationships among these terms, ontologies make information about content explicit for computers, allowing them to discover common meaning in diverse data sets. Thus, ontologies are an important component of many bioinformatics applications (Jensen and Bork, 2010), and they form the foundation of the semantic web (Berners-Lee et al.,

ONTOLOGIES AS INTEGRATIVE TOOLS FOR PLANT SCIENCE¹

RAMONA L. WALLS^{2,9}, BALAJI ATHREYA³, LAUREL C. MARIANO⁴, MARIA A. GANDOLFO^{4,9}, PANKAJ JAISWAL^{3,9}, CHRISTOPHER STEFAN RENSING⁶, BARRY SMITH⁷, AND DENNIS

²New York Botanical Garden, 2900 Southern Blvd., Bronx, New York 10458-5020; ³Department of Plant Pathology, Oregon State University, 2082 Cordley Hall, Corvallis, Oregon 97331; ⁴Department of Plant Biology, Cornell University, 412 Mann Library Building, Ithaca, New York 14853; ⁵Berkeley Bioinformatics Open-Source Projects, Lawrence Berkeley National Laboratory, Berkeley, California 94720 USA; ⁶Faculty of Biology, University of Freiburg, Schleicherschneisen 1, Freiburg, Germany; ⁷Department of Philosophy, University at Buffalo, 126 Park Hall, Buffalo, New York 14260

⁸Berkeley Bioinformatics Open-Source Projects, Lawrence Berkeley National Laboratory, Berkeley, California 94720 USA; ⁹Faculty of Biology, University of Freiburg, Schleicherschneisen 1, Freiburg, Germany

- *Premise of the study:* Bio-ontologies are essential tools for accessing and analyzing genomic and phenomic data. Ontologies provide structured vocabularies to support computational frameworks for automated analyses and reasoning. They are a key component of modern plant science.
- *Methods:* This paper provides background on what bio-ontologies are, why they are important, and how they are developed. It includes an overview of ontologies and related resources, a detailed description of the Plant Ontology (PO). We discuss the challenges of bio-ontology development (Viridiplantae).
- *Key results:* Ontologies can advance plant science in four key areas: (1) comparative plant development; (2) taxonomy and systematics; (3) semantic applications; and (4) data integration.
- *Conclusions:* Bio-ontologies offer a flexible framework for comparative plant science. As genomic and phenomic data become available for more species, ontology terms will become less centralized, while at the same time, the need for common terms is increasing, causing more researchers in plant science to turn to ontologies.

Key words: bio-ontologies; genome annotation; OBO Foundry; phenomics; plant systematics; semantic web.

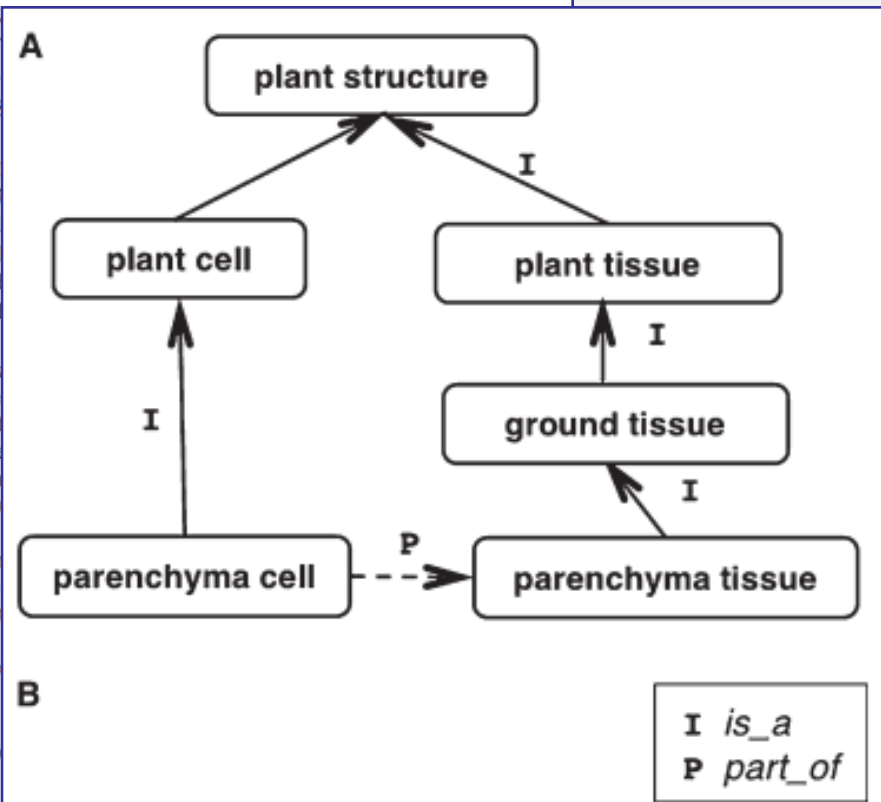

Data overload is an issue for nearly every branch of plant science. The amount of data is growing larger and more complex. All this information creates

TABLE 1. Ontologies and other related resources for plant science.

Resource (abbreviation)	Domain	References
Plant Ontology (PO)	Plant anatomical entities and plant structure development stages	(Pujar et al., 2006; Ilic et al., 2007)
Gene Ontology (GO)	Cellular components, biological processes, and molecular functions	(Gene Ontology Consortium, 2009) http://www.geneontology.org/
Chemical Entities of Biological Interest (ChEBI)	Molecular entities that are natural products or are synthetic products used to intervene in the processes of living organisms	(Degtyarenko et al., 2007; de Matos et al., 2009) http://www.ebi.ac.uk/chebi/
Protein Ontology (PR)	Proteins based on evolutionary relatedness, protein forms produced from a given gene locus, and protein-containing complexes	(Natale et al., 2007; Bult et al., 2011) http://pir.georgetown.edu/pro/
Ontology for Biomedical Investigations (OBI)	Scientific investigations, including the protocols and instrumentation used, the material used, the data generated, and the types of analysis performed	(Brinkman et al., 2010) http://obi-ontology.org
Phenotypic Quality Ontology (PATO)	Phenotypic qualities (properties). This ontology can be used in conjunction with other ontologies such as anatomical ontologies to refer to phenotypes.	(Mungall et al., 2010) http://obofoundry.org/wiki/index.php/PATO:Main_Page
Plant Trait Ontology (TO)	Phenotypic traits in plants; each trait is a distinguishable feature, characteristic, or quality of a plant	(Jaiswal, 2011) http://www.gramene.org/db/ontology/search?id=TO:0000387
Plant Infectious Disease Ontology (IDOPlant)	Plant infectious diseases, pathogens, and symptoms	(Walls et al., in press) http://purl.obolibrary.org/obo/idoplant.owl
Extensible Observation Ontology (OBOE)	A suite of ontologies for modeling and representing scientific observations	(Madin et al., 2007) https://semtools.ecoinformatics.org/obo/
Environment Ontology (EnvO)	Environmental features and habitats	http://environmentontology.org/
NCBI Taxonomy	Biological taxa, based on the classification of the National Center for Biotechnology Information	(Wheeler et al., 2007) http://obofoundry.org/cgi-bin/detail.cgi?id=ncbi_taxonomy
BioPortal	Source for finding, searching and querying bio-ontologies	http://biportal.bioontology.org/
Ontology Lookup Service	Source for finding and searching bio-ontologies	(Côté et al., 2006) http://www.ebi.ac.uk/ontology-lookup/
OntoBee	Source for finding, searching and querying bio-ontologies	(Xiang et al., 2011) http://ontobee.org

Ontologías hoy

- Retos:
 - Falta de vocabularios completos que cubran grupos amplios de organismos (p.e. plantas)
 - No todas las entidades observables pueden adscribirse “limpiamente” a las categorías establecidas (p.e. que es un septo de un fruto)
 - Homologías discutibles
 - Pérdida de detalle en las generalizaciones
 - Etc.

Web semántica: navegar los datos como el metro de una ciudad



- Bases de datos conectadas por ontologías y la Web
- Conseguir que podamos inferir hechos a partir de datos distribuidos

Hacia donde vamos

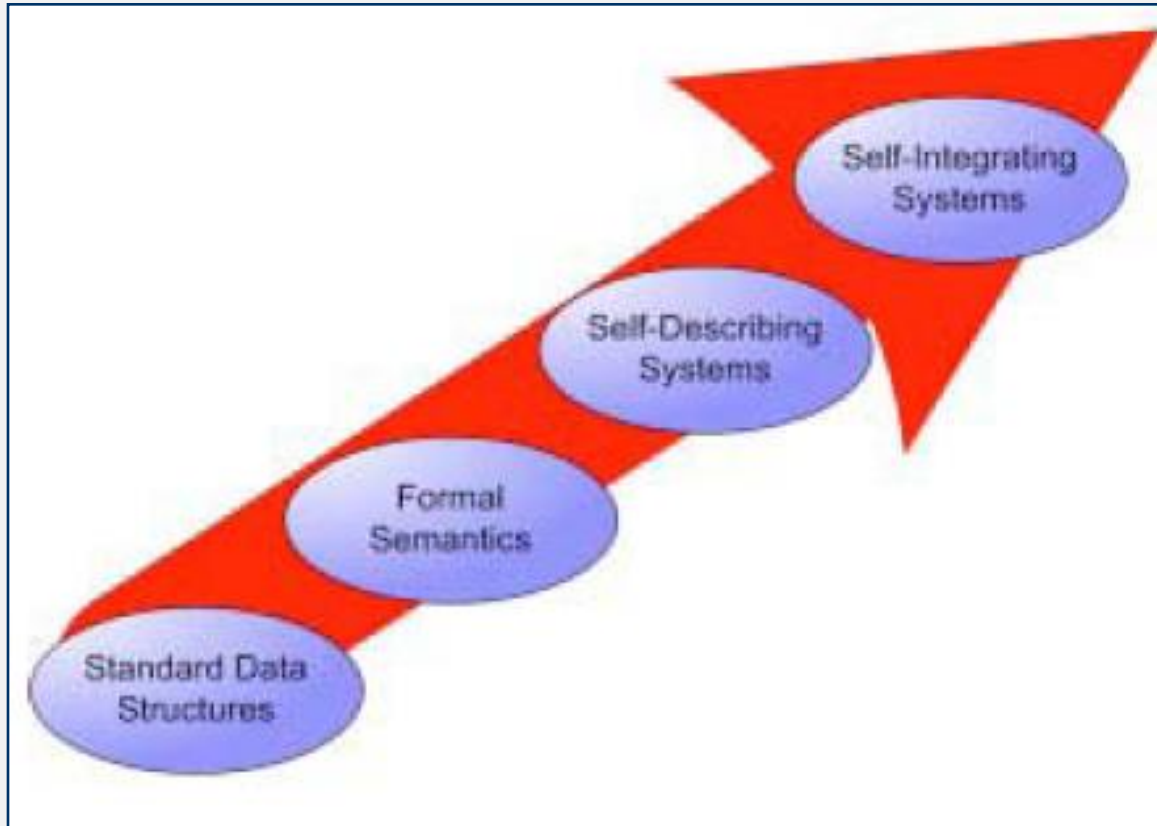

La idea es que la web funciona como un único sistema de información

XML

Los contenidos se tienden a codificar usando un metalenguaje llamado XML (Extensible markup Language).

Las definiciones y relaciones se expresan usando una implementación de XML llamada XSD (*XML Schema Definition*)

XML

```
<?xml version="1.0" encoding="UTF-8"?>
<correo xmlns="http://www.ideo.es" xmlns:xsi="http://www.ideo.es/xsi"
instance="http://www.ideo.es/correo.xsd">
  <origen>alice@mfom.es</origen>
  <destino>bob@mfom.es</destino>
  <asunto>Avances IDEE</asunto>
  <texto>La IDE de Andalucía se incorporará a la IDEE en breve.</texto>
</correo>
```

❖ Documento XML

```
<?xml version="1.0"?>
<xs:schema xmlns:xs="http://www.w3.org/2001/XMLSchema"
targetNamespace="http://www.ideo.es"
xmlns="http://www.ideo.es" elementFormDefault="qualified">
  <xs:element name="correo">
    <xs:complexType>
      <xs:sequence>
        <xs:element name="origen" type="xs:string"/>
        <xs:element name="destino" type="xs:string"/>
        <xs:element name="asunto" type="xs:string"/>
        <xs:element name="cuerpo" type="xs:string"/>
      </xs:sequence>
    </xs:complexType>
  </xs:element></xs:schema>
```

❖ Esquema XML



BY

Web semántica en acción: “Linked (open) data”

¿Qué es Linked Data?

Los Datos Enlazados es la forma que tiene la Web Semántica de vincular los distintos datos que están distribuidos en la Web, de forma que se referencian de la misma forma que lo hacen los enlaces de las páginas web.

La Web Semántica no se trata únicamente de la publicación de datos en la Web, sino que éstos se pueden vincular a otros, de forma que las personas y las máquinas puedan explorar la web de los datos, pudiendo llegar a información relacionada que se hace referencia desde otros datos iniciales.

¿Cómo funciona?

Los Datos Enlazados, como parte de la Web Semántica, se basa en la aplicación de ciertos principios básicos y necesarios, que fomentarán el crecimiento de la Web, tanto a nivel de los documentos HTML (vista clásica de la Web), como a nivel de los datos expresados en RDF (vista de la Web Semántica).

1. Usar URIs para identificar las cosas
2. Usar URIs HTTP
3. Ofrecer información sobre los recursos usando RDF
4. Incluir enlaces a otros URIs

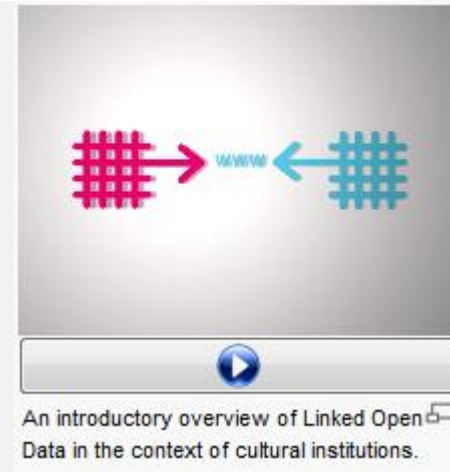

- <http://www.youtube.com/watch?v=uju4wT9uBIA>

Linked Data and the Charm of Weak Semantics

Introduction: The Strengths of Weak Semantics

by Thomas Baker and Stuart A. Sutton

Linked Data and the Charm of Weak Semantics

EDITOR'S SUMMARY

Logic and precision are fundamental to ontologies underlying the semantic web and, by extension, to linked data. This special section focuses on the interaction of semantics, ontologies and linked data. The discussion presents the Simple Knowledge Organization Scheme (SKOS) as a less formal strategy for expressing concept hierarchies and associations and questions the value of deep domain ontologies in favor of simpler vocabularies that are more open to reuse, albeit risking illogical outcomes. RDF ontologies harbor another unexpected drawback. While structurally sound, they leave validation gaps permitting illogical uses, a problem being addressed by a W3C Working Group. Data models based on RDF graphs and properties may replace traditional library catalog models geared to predefined entities, with relationships between RDF classes providing the semantic connections. The BIBFRAME Initiative takes a different and streamlined approach to linking data, building rich networks of information resources rather than relying on a strict underlying structure and vocabulary. Taken together, the articles illustrate the trend toward a pragmatic approach to a Semantic Web, sacrificing some specificity for greater flexibility and partial interoperability.

KEYWORDS

linked data
RDF

semantic networks
ontologies

Thomas Baker, an organizer of the Dublin Core Metadata Initiative, is an associate professor at Sungkyunkwan University in Seoul, South Korea. He can be reached at tb12@thbaker.org.

Stuart A. Sutton, associate professor emeritus in the Information School of the University of Washington, is managing director of the Dublin Core Metadata Initiative. He can be reached at sasutton@uw.edu.

When the meme first emerged in the late 1990s, *Semantic Web* stood for logical data processing on the foundation of World Wide Web technology. One of its roots reached back to the 1955 meme of *artificial intelligence*, with its notion “that every aspect of learning or any other feature of intelligence can in principle be so precisely described that a machine can be made to simulate it.” [1, p. 12] The Semantic Web specifications developed by the World Wide Web Consortium from the late 1990s through the mid-2000s – the Resource Description Framework (RDF) and the Web Ontology Language (OWL) – were anchored in the notion of *ontology* as a “formal, explicit specification of a shared conceptualization” as supported by the field of ontology engineering.

Around 2006, Semantic Web was joined by the related, but more accessible and ultimately more popular meme of *linked data*. Starting with a cluster of databases linked to and from Wikipedia, the linked data movement took a more inclusive view of data technologies, with data serialized for Semantic Web-based interoperability as the five-star summit that providers of data in proprietary or application-specific document, database and record formats could by incremental steps ascend.

The contributions to this issue of the *Bulletin of the Association for Information Science and Technology* address, from five perspectives, how the shift to the idea of linked data at scale has changed the role of semantically precise ontologies.

As Oscar Corcho, María Poveda-Villalón and Asunción Gómez-Pérez see it, linked data has put the field of ontology engineering into a new context. Where tradition has favored heavyweight ontologies that demonstrate deep understanding of a domain and enable sophisticated inferences, the

Una propuesta para organizar, publicar, integrar
y mantener información especies

Ideas /requisitos

- Sistema que permita:
 - publicar y utilizar información de especies;
 - establecer equivalencias entre distintas listas y catálogos de especies y
 - que haga posible combinar información de distintos catálogos de acuerdo a relaciones de equivalencia entre las fichas de los mismos.

Ideas /requisitos

También:

- que los catálogos que conecten puedan estar distribuidos y administrados allá donde se compilen (los distintos proyectos o administraciones que los tengan),
- que soporte versiones sucesivas (e.g. lista de aves del 2011, del 2016),
- que funcione como infraestructura, esto es, que lo que se crea tenga vocación de permanecer en el tiempo y que se le dote de las necesarias "pasarelas" (en la práctica web services o APIs) para que aplicaciones y sistemas externos puedan utilizar la información a la que da acceso.

Propuesta de arquitectura

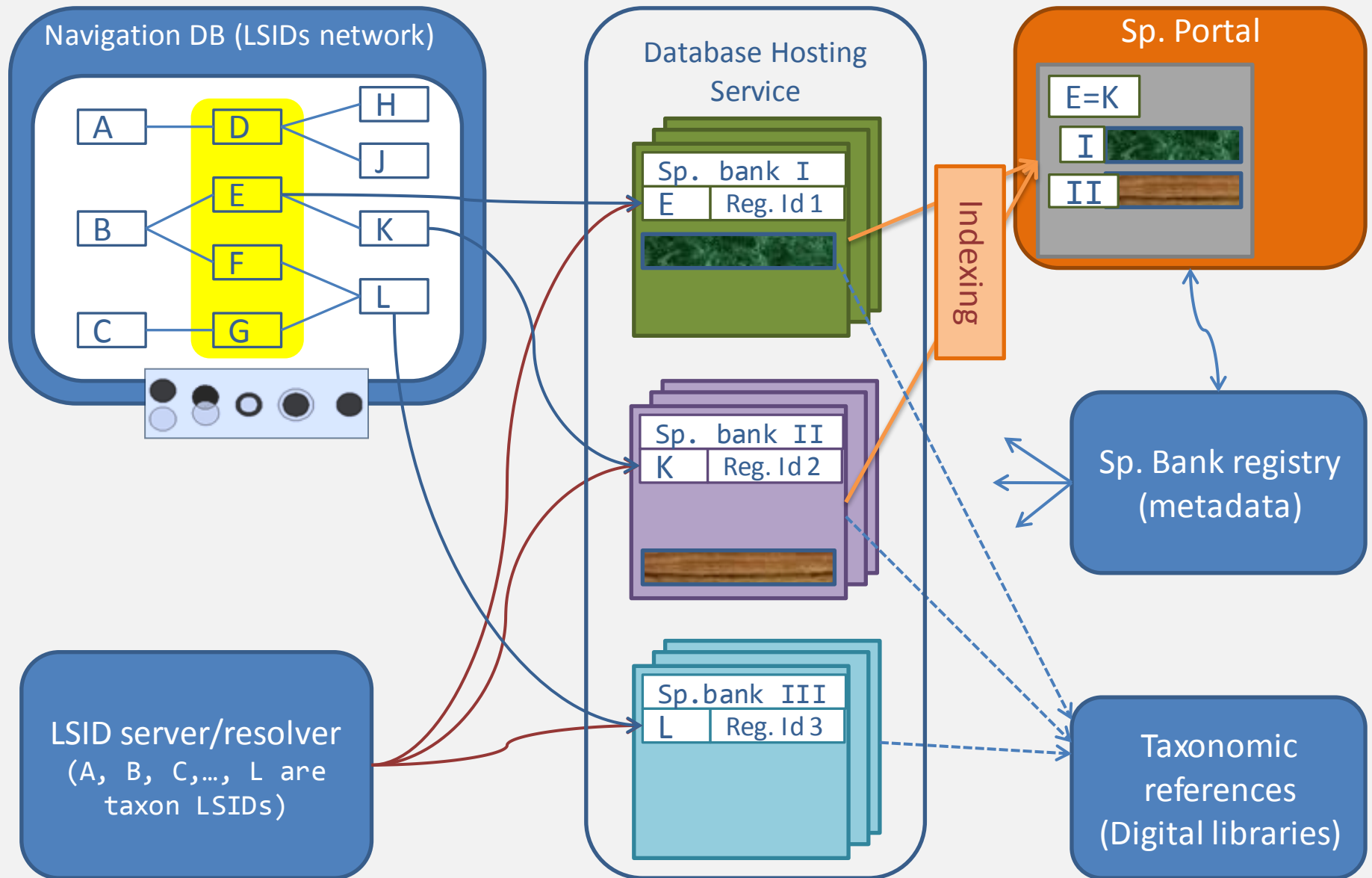

BBDD de “navegación entre LSIDs”

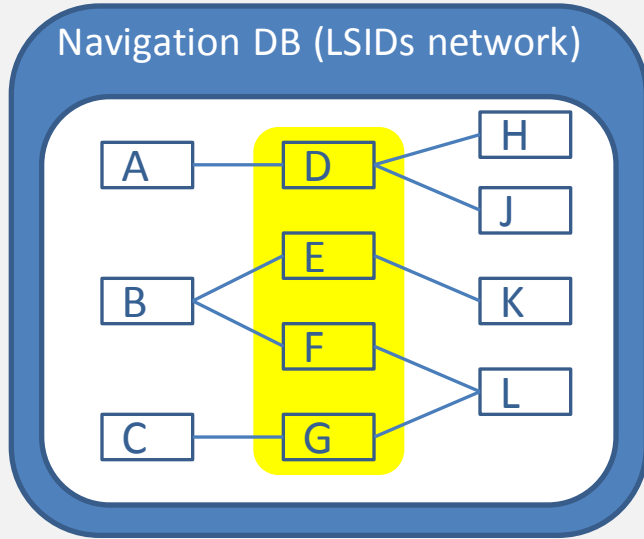

R1. PT1 and PT2 are congruent
 $PT1 \equiv PT2$ $x \in PT1 \Leftrightarrow x \in PT2$



R2. PT1 is included in PT2
 $PT1 \subset PT2$ $x \in PT1 \Rightarrow x \in PT2, \exists y \in PT2 | y \notin PT1$



R3. PT1 includes PT2
 $PT1 \supset PT2$ $x \in PT2 \Rightarrow x \in PT1, \exists y \in PT1 | y \notin PT2$



R4. PT1 and PT2 overlap each other
 $PT1 \oplus PT2$ $\exists x \in PT1 | x \notin PT2, \exists y \in PT2 | y \notin PT1,$
 $\exists z \in PT1 | z \in PT2$

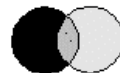

R5. PT1 and PT2 exclude each other
 $PT1 \perp PT2$ $x \in PT1 \Rightarrow x \notin PT2$



Schriftenreihe für Vegetationskunde
 Volume 39

MoReTax

Handling Factual Information
 Linked to Taxonomic Concepts
 in Biology

B-N
 BUNDESLANDESMUSEUM
 NATURHISTORISCHES MUSEUM
 WÜRZBURG

LSID server /resolver

LSID server/resolver
(A, B, C,..., 1 are
taxon LSIDs)

LSIDs para:

Nombres

Publicaciones

Táxones (conceptos)

Catálogos (SpBans)

Adoption of Persistent Identifiers for Biodiversity Informatics

Recommendations of the GBIF LSID GUID Task Group,
28 September 2009

*Phil Cryer (Missouri Botanical Garden),
Roger Hyam (Natural History Museum, London, and PESI),
Chuck Miller (Missouri Botanical Garden),
Nicola Nicolson (Royal Botanic Gardens, Kew),
Éamonn Ó Tuama (GBIF),
Rod Page (University of Glasgow),
Jonathan Rees (Science Commons),
Greg Riccardi (co-chair, Florida State University),
Kevin Richards (Landcare Research, New Zealand),
Richard White (co-chair, Cardiff University)*

Summary

Effé
GBI
GBI
Lea
feed
beir
prio
the

<http://imgbif.gbif.org/File/retrieve.php?PATH=4&FILE=2efc20187e6ad3dd828bbeadaa1040e6&FILENAME=LGTGReportDraft.pdf&TYPE=application/pdf>

data. If
adoption.
The
of data
as a high
mandates
accepted by the postal.

zoobank.org/?lsid=urn:lsid:zoobank.org:act:8BDC0735-FEA4-4298-83FA-D04F67C3FBEC

 **ZooBank**

Menu ▾ The Prototype Online Registry for Zoological Nomenclature

NOMENCLATURE ACT

urn:lsid:zoobank.org:act:8BDC0735-FEA4-4298-83FA-D04F67C3FBEC **LSID** [Short URL]
Time Stamp: 2008-01-01T00:00:02 Registered By: Richard L. Pyle

Chromis abyssus Pyle, Earle & Greene 2008

Act Type:	Original Description
Published In:	Pyle, Richard L., John L. Earle & Brian D. Greene. 2008. Five new species of the damselfish genus <i>Chromis</i> from coral reefs in the tropical western Pacific. <i>Zootaxa</i> , 1671:3-31.
Page(s):	Not known.
Spelling:	abyssus
Authorship:	Pyle, Earle & Greene
Rank:	Species
Placement:	Chromis
Full Name:	Chromis abyssus
Type(s):	Not entered into ZooBank.
Type Locality:	Not entered into ZooBank.

Sources:        

Catálogos de especies

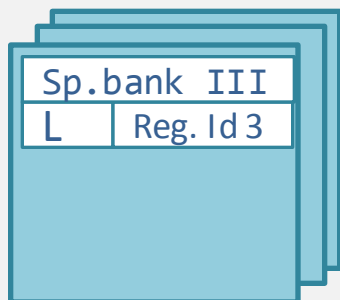
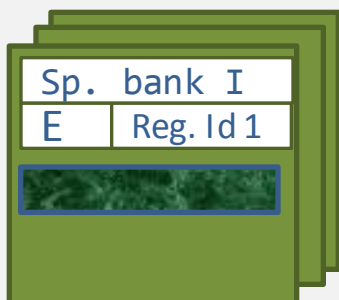

Publicados como PliC
Focalizados en proyectos

Nodo Nacional de Información en Biodiversidad

Portal de Especies y Especímenes de GBIF.ES

Buscar Español | English

GBIF.ES

Detalles del registro de especies: *Rosa sempervirens* (Proveedor de Especies de GBIF España - Flora Micológica Ibérica.Especies)

Principal
Clasificación
Países
Recursos de datos
Ocurrencias
Registro de especies
Acerca de

Rosa sempervirens

Acciones

Encontrar:

- Registros para *Rosa sempervirens* de Flora Micológica Ibérica.Especies

Recuperar:

- Obtener el registro original del proveedor de datos

Ver:

- Ver información para *Rosa sempervirens*
- Classification de *Rosa sempervirens* de acuerdo a Flora Micológica Ibérica.Especies

Enviar:

- Retroalimentación a Proveedor de Especies de GBIF España

Recurso de datos

Información

Taxonomía

Descripcion

Descripcion breve:

Descripcion científica:

Arbusto de hasta 6 m o más. Tallos trepadores o procumbentes, rara vez erectos, delgados, glabros, verdes o rojizos; acúleos homogéneos, curvos, retrorsos, de sección subcircular u oblonga, dispersos. Hojas perennes, coriáceas, con 2 acúleos subestipulares; folíolos (3)5, de (2,5)3-8 × 1,5-3,5 cm, de ovados a ovado-lanceolados, glabros, brillantes por el haz, acuminados, con 18-29 pares de dientes, simples, poco profundos; peciolo y raquis glabros o pubérulos, con algunas glándulas estipitadas ?a veces espinescentes?, y con pequeños acúleos muy dispersos, que pueden extenderse por el raquis; estípulas 9-19 × 2-4 mm, de margen con glándulas estipitadas o sin ellas, aurículas estrechas, divergentes, glabras. Flores 1-3(-12), solitarias o en inflorescencia corimbiforme; brácteas 1-2, de 4-15(19) × 3-4,5(6) mm, caducas, ovado-lanceoladas, acuminadas y revueltas, frecuentemente con glándulas estipitadas, muy dispersas, por el margen y a veces por el envés; pedicelos 2-5 cm, con glándulas estipitadas, muy densas hacia el ápice. Receptáculo con disco de 3-5 mm, plano o apenas cónico; orificio 0,7-1 mm. Sépalos 9-13 × 4-6 mm, caducos y reflejos, ovados, acuminados, enteros ?rara vez con pequeños lóbulos marginales?, con glándulas estipitadas en el dorso y margen, acompañadas

Portal

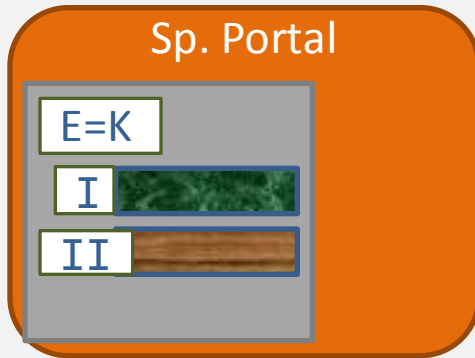

- Mucho por definir
- Apoyado en EoL, Herbario Virtual de Andalucía, ALA,...

Registro / metadatos

- GBIF Metadata profile
- Compatible con la infraestructura de metadatos de GBIF.ES (MetaGes)
- Con Interfaz OAI-PMH

Sp. Bank registry
(metadata)

Referencias taxonómicas

Taxonomic
references
(Digital libraries)

Apoyada en la Bib.Dig. RJB,
pero no limitada a ella



Recapitulando y para recordar (y discutir)

- El triplete taxon-nombre- descripción
- Identificadores (UGPR)
- Marco conceptual común (Plinian)

Francisco Pando

Unidad de coordinación, GBIF España
Real Jardín Botánico - CSIC
Claudio Moyano 1, 28014 Madrid, Spain
pando@gbif.es
www.gbif.es

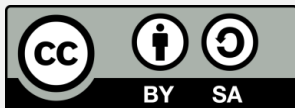

<http://creativecommons.org/licenses/by-sa/3.0/es/>

GBIF-ES es el Nodo Nacional de Información sobre Biodiversidad patrocinado por el [Ministerio Español de Economía y Competitividad](#), gestionado por el [Consejo Superior de Investigaciones Científicas](#).

